

New ASHRAE Thermal Guidelines for Air and Water Cooling

*Michael J. Ellsworth, Jr., P.E.
Senior Technical Staff Member
IBM Corporation
Poughkeepsie, NY USA
mje@us.ibm.com*

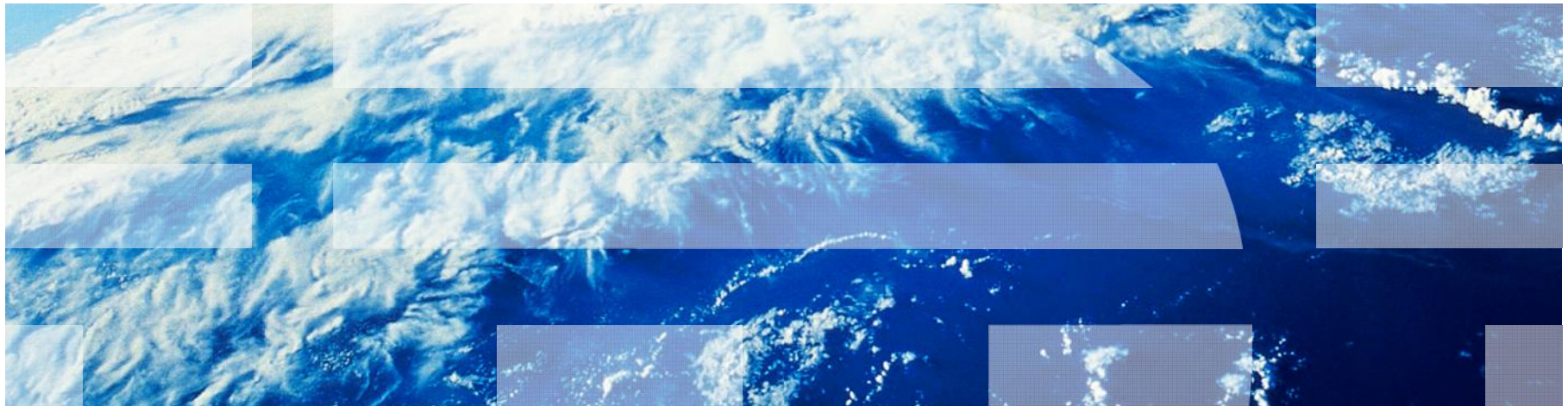

Third Annual Workshop on Energy Efficient High Performance Computing –
Redefining System Architecture and Data Centers
Supercomputer 2012 Energy Efficient High Performance Computing Work Group Workshop
November 11, 2012

ASHRAE Technical Committee 9.9

Title: Mission Critical Facilities, Technology Spaces, & Electronic Equipment

Overview:

- Concerned with the design, operations, maintenance, and efficient energy usage of modern data centers and technology spaces.
- The committee is comprised of a wide range of industry representatives including but not limited to equipment manufacturers, consulting engineers, data center operators, academia, testing laboratories, government, etc. who are all committed to increasing and sharing the body of knowledge related to data centers.
- The ASHRAE TC 9.9 Datacom* Series, a series of nine publications, provides a comprehensive treatment of datacom cooling and related subjects.



* - datacom: data processing and telecommunications equipment

ASHRAE's Thermal Guidelines Book - 2nd Edition (2009)

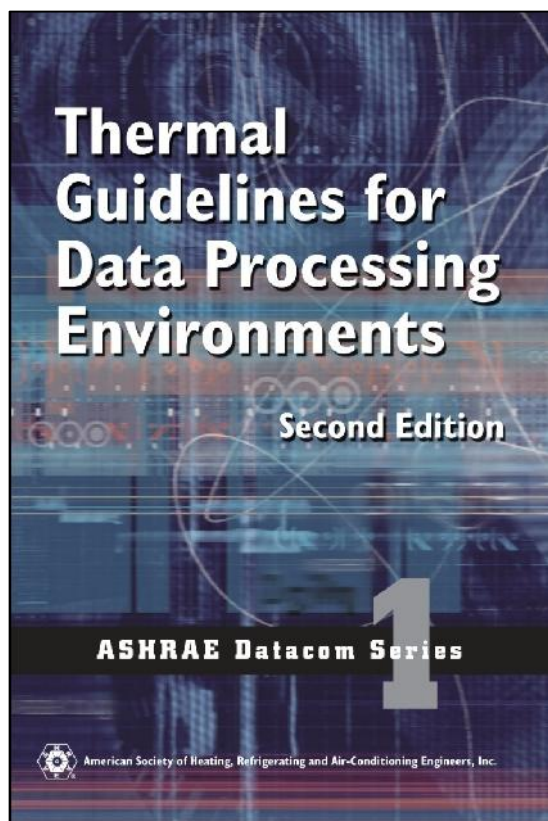

- **Chapter 1** – Introduction
- **Chapter 2** – Equipment Environmental Specifications
- **Chapter 3** – Facility Temperature & Humidity Measurement
- **Chapter 4** – Equipment Placement & Airflow Patterns
- **Chapter 5** – Equipment Manufacturers Heat & Airflow Reporting
- **Appendix A** – Psychrometric Charts
- **Appendix B** – Temperature & Altitude Charts

Can obtain book @ <http://tc99.ashraetcs.org/>

ASHRAE IT Equipment Environment - Class Definition

- Recommended & Allowable Environmental Conditions vary depending on the application, scale & type of electronic equipment that is being cooled.

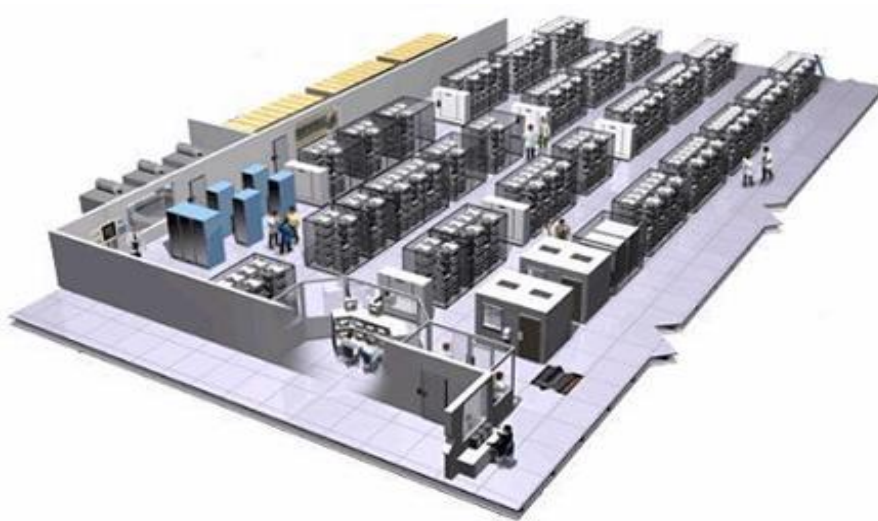

Class 1 – Data Center

- Enterprise and Volume Servers
- Storage products



Class 2 – Office Space



Class 3 – Home Office



Class 4 – Point of Sale

Thermal Guidelines - 2st Edition (2008)

- ❖ Expanded recommended range
- ❖ Increased opportunity to use compressor-less cooling solutions

Class	Product Operation (Powered On)				
	Dry-Bulb Temperature		Relative Humidity (%) Non-Condensing		Max Dew Point
	Allowable	Recommended	Allowable	Recommended	
1	15 to 32 °C (59 to 89.6 °F)	See table below	20 to 80	See table below	17 °C (62.6 °F)
2	10 to 35 °C (50 to 95 °F)		20 to 80		21 °C (69.8 °F)
3	5 to 35 °C (41 to 95 °F)	N/A	8 to 80	N/A	28 °C (82.4 °F)
4	5 to 40 °C (41 to 104 °F)	N/A	8 to 80	N/A	28 °C (82.4 °F)

	2004 Version	2008 Version
Low End Temperature	20 °C (68 °F)	18 °C (64.4 °F)
High End Temperature	25 °C (77 °F)	27 °C (80.6 °F)
Low End Moisture	40% RH	5.5 °C (41.9 °F) DP
High End Moisture	55% RH	60% RH & 15 °C (59 °F) DP

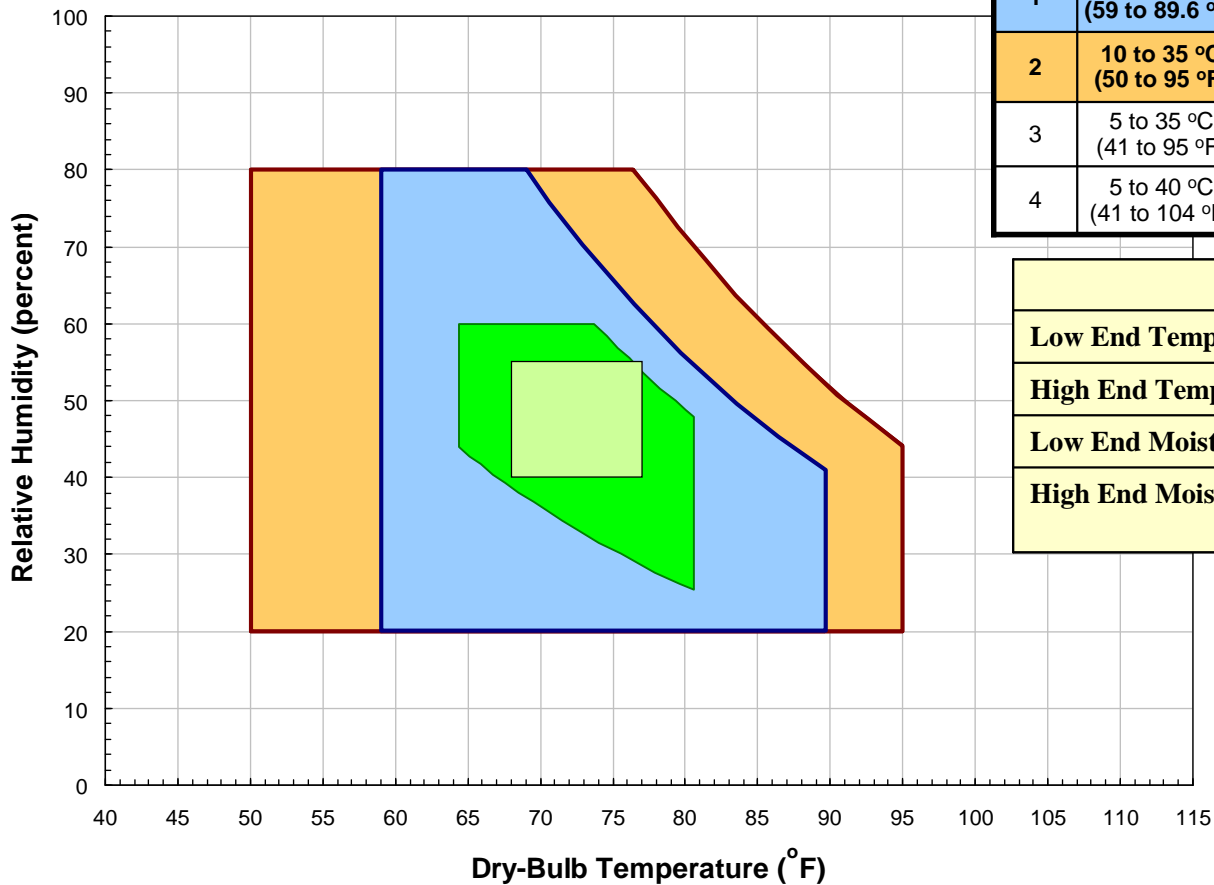

■ Class 1
 ■ Recommended (2004)
 ■ Class 2
 ■ Recommended (2008)

IT Equipment Environment - Envelope Definitions

Recommended – The purpose of the recommended envelope is to give guidance to data center operators on maintaining high IT reliability while still achieving reasonably energy-efficient data center operation

Allowable – The allowable envelope is where the IT manufacturers test their equipment in order to verify that the equipment will function within those environmental boundaries.

Prolonged Exposure – Prolonged exposure of operating IT equipment to conditions outside its recommended range, especially approaching the extremes of the allowable operating environment, can result in decreased equipment reliability and longevity. It is acceptable to operate outside the recommended envelope for occasional, short periods of time without affecting the overall reliability and operation of the IT equipment.

Thermal Guidelines - 2011 Whitepaper

Class	Product Operation (Powered On)				
	Dry-Bulb Temperature		Relative Humidity (%) Non-Condensing		Max Dew Point
	Allowable	Recommended	Allowable	Recommended	
A1	15 to 32 °C (59 to 89.6 °F)		20 to 80		17 °C (62.6 °F)
A2	10 to 35 °C (50 to 95 °F)		20 to 80		5.5 °C (41.9 °F) DP
A3	5 to 40 °C (41 to 104 °F)	18 to 17 °C (64.4 to 80.6 °F)	-12 °C (10.4 °F) DP and 8% RH to 85% RH	to 60% RH and 15 °C (59 °F) DP	24 °C (75.2 °F)
A4	5 to 45 °C (41 to 113 °F)		-12 °C (10.4 °F) DP and 8% RH to 90% RH		24 °C (75.2 °F)
B	5 to 35 °C (41 to 95 °F)	N/A	8 to 80	N/A	28 °C (82.4 °F)
C	5 to 40 °C (41 to 104 °F)	N/A	8 to 80	N/A	28 °C (82.4 °F)

2011 Classes	2008 Classes	Application	IT Equipment	Environmental Control
A1	1	Datacenter	Enterprise servers, storage products	Tightly controlled
A2	2		Volume servers, storage products, personal computers, workstations	Some Control
A3	n/a			
A4	n/a			
B	3	Office, home, trans-portable equipment, etc.	Personal computers, workstations, laptops, and printers	Minimal Control
C	4	Point-of-sale, industrial factory, etc.	Point-of-sale equipment, ruggedized controllers, or computers and PDAs	No Control

- ✓ Created 2 additional environmental classes to enable improved PUE capability
- ✓ Provide guidance on the usage of the existing and new classes
- ✓ Clients are wanting to further minimize the use of chillers throughout the year (results in large energy savings)
- ✓ European Union Code of Conduct for Data Centers Group is made up of users who are pushing to widen the IT environmental guidelines to reduce the number of hours required for chillers

Source: Whitepaper prepared by ASHRAE Technical Committee 9.9 Mission Critical Facilities, Technology Spaces, and Electronic Equipment entitled, "2011 Thermal Guidelines for Data Processing Environments – Expanded Data Center Classes and Usage Guidance," <http://tc99.ashraetcs.org/>, 2011.

Thermal Guidelines - 2011 Whitepaper

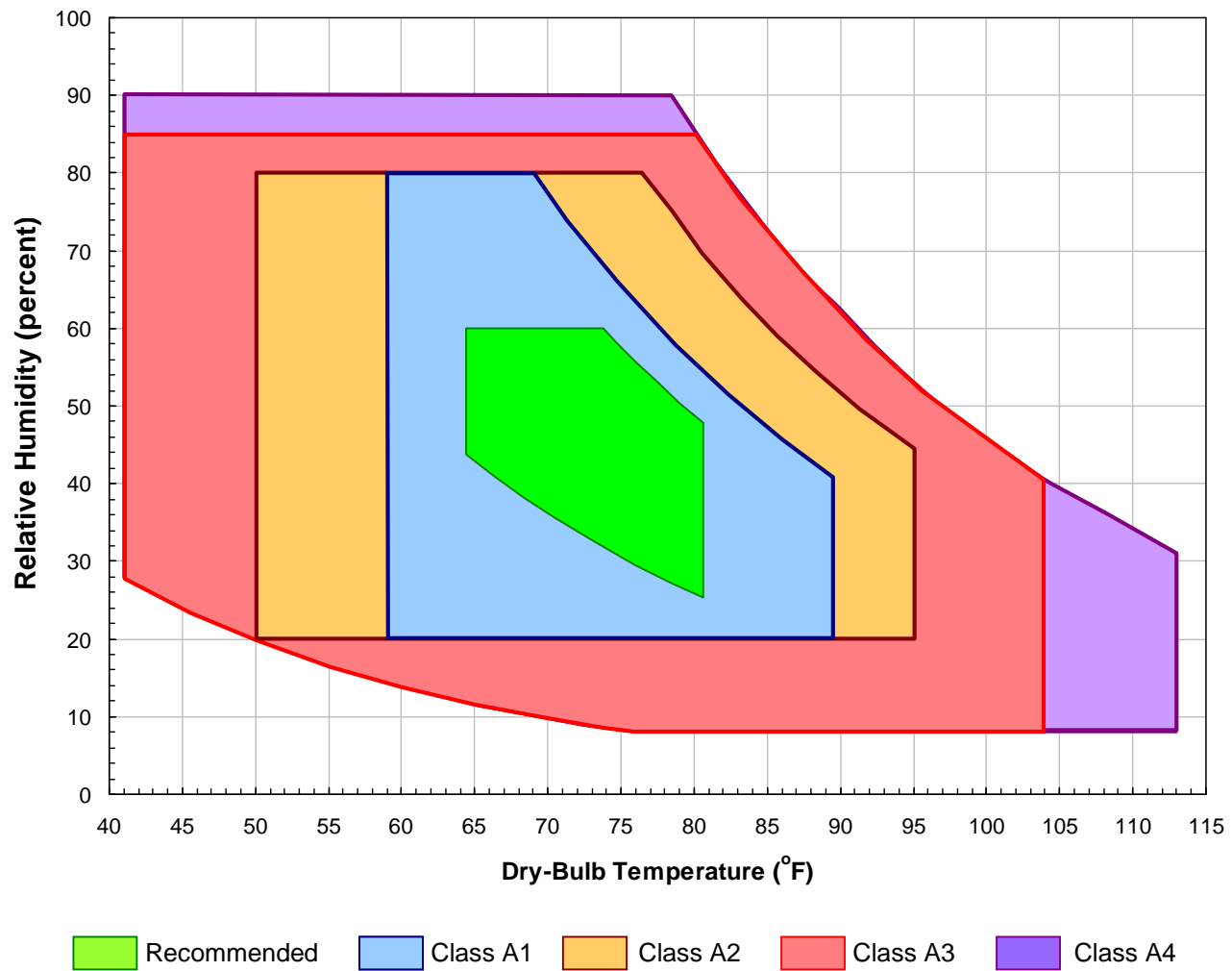

Guide for the Use and Application of the ASHRAE Data Center Classes

Operation outside the recommended region should be a balance between energy savings and the deleterious effects that may be created in reliability, acoustics, or performance.

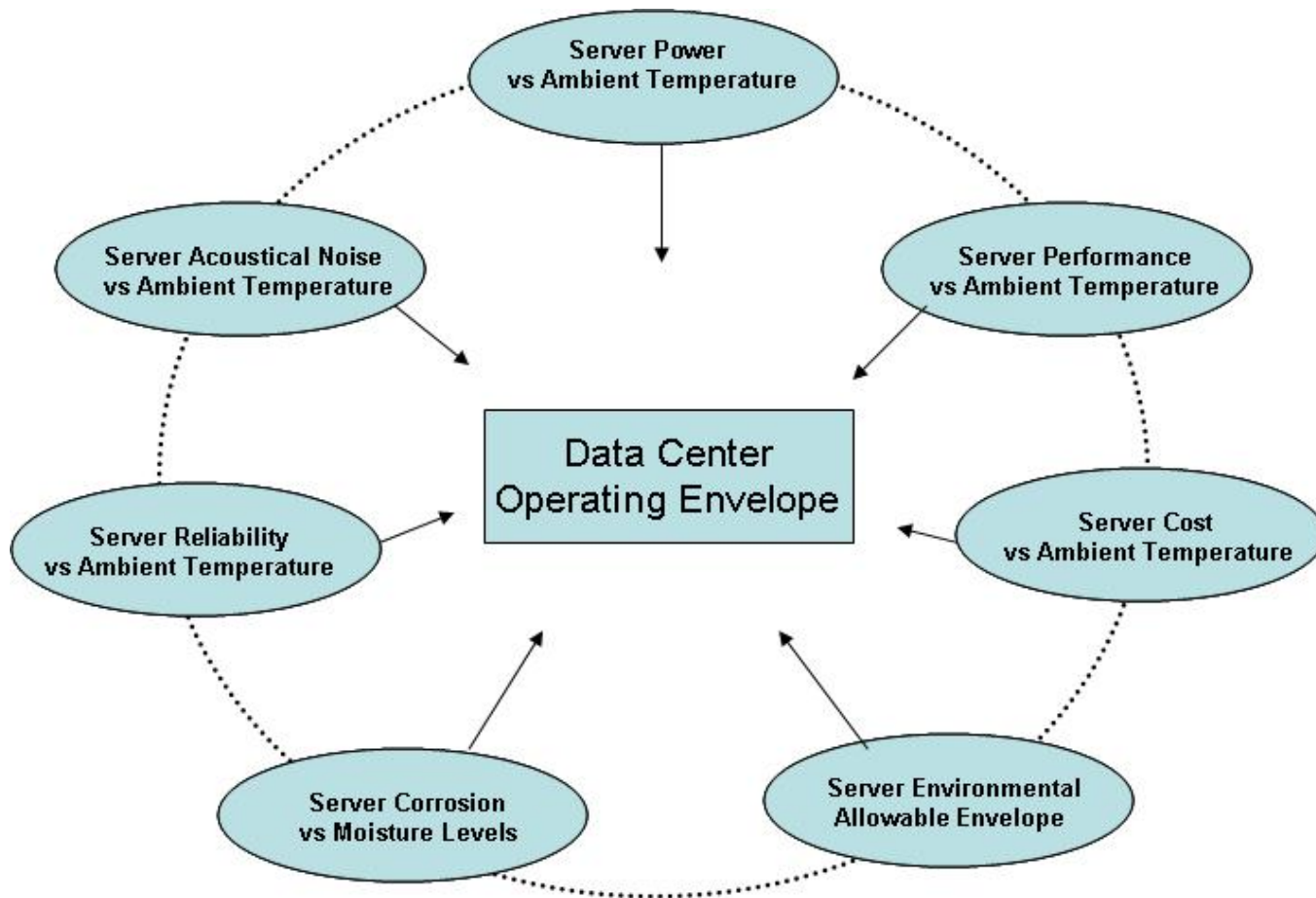

Server Power Trend vs. Ambient Temperature

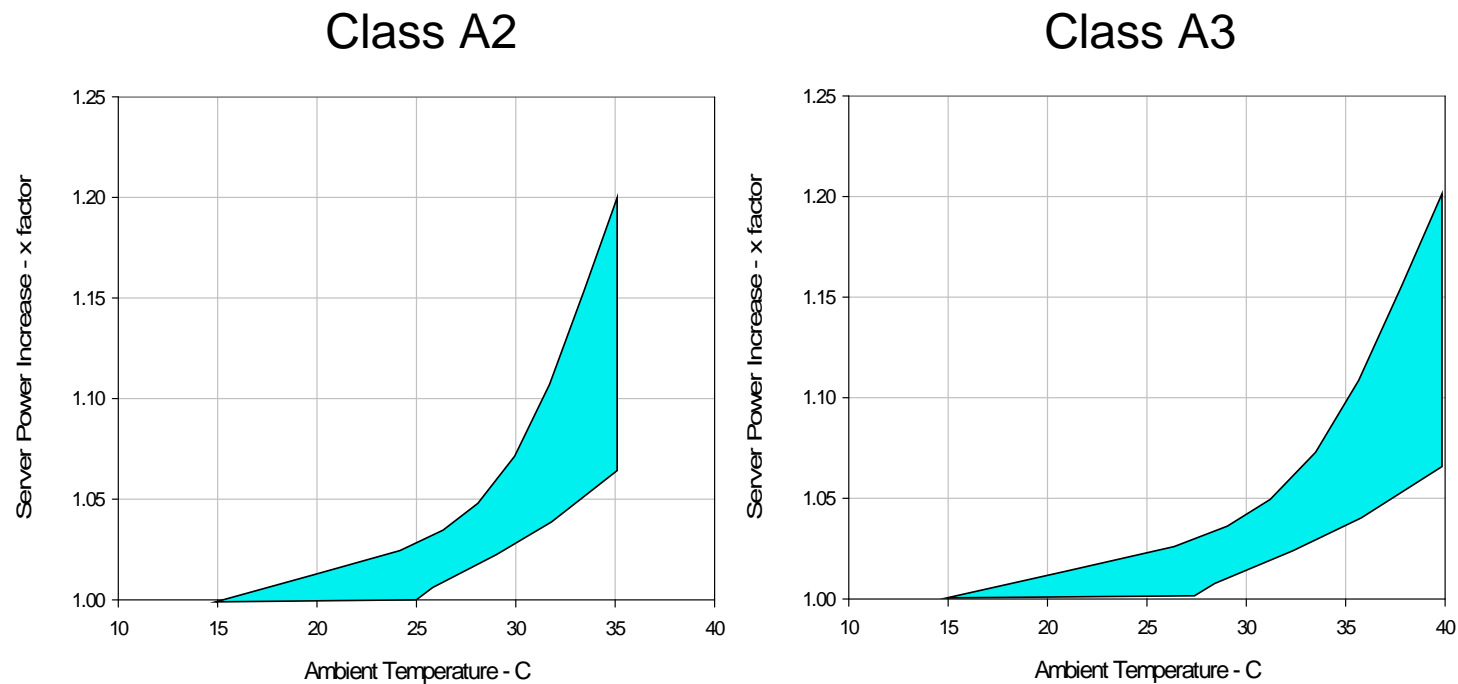

- Increase component power (leakage current)
- Increased fan power (increased air flow)
- Decreased power conversion efficiency

Server Reliability Trend vs Ambient Temperature

Dry Bulb Temperature (C)	Average Failure Rate X-Factor	Lower Bound of Failure Rate X-Factor	Upper Bound of Failure Rate X-Factor
15	0.72	0.72	0.72
17.5	0.87	0.80	0.95
20	1.00	0.88	1.14
22.5	1.13	0.96	1.31
25	1.24	1.04	1.43
27.5	1.34	1.12	1.54
30	1.42	1.19	1.63
32.5	1.48	1.27	1.69
35	1.55	1.35	1.74
37.5	1.61	1.43	1.78
40	1.66	1.51	1.81
42.5	1.71	1.59	1.83
45	1.76	1.67	1.84

Table C-1. Relative hardware failure rate x-factor for volume servers as a function of continuous (7 days x 24 hours x 365 days) operation air inlet temperature (indexed to 20°C.)

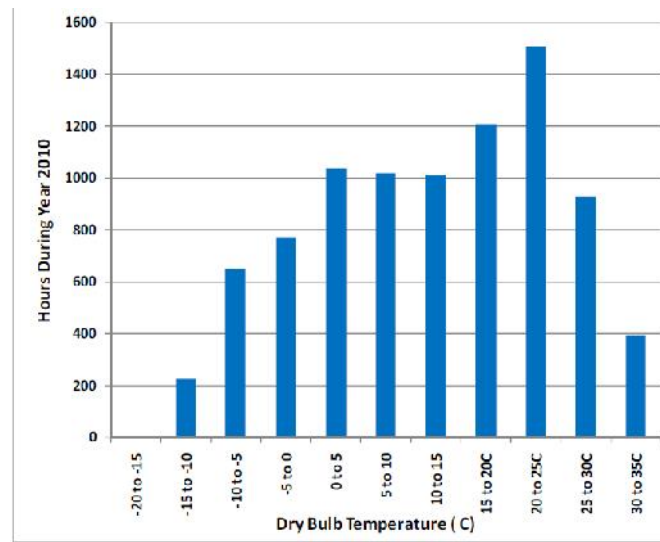

Figure 5. Histogram of dry bulb temperatures for the city of Chicago for the year 2010.

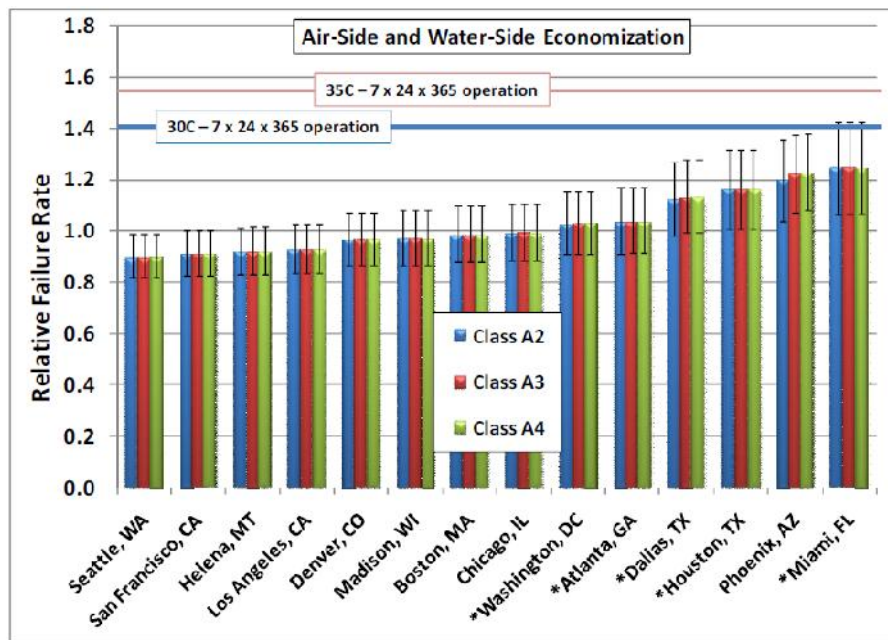
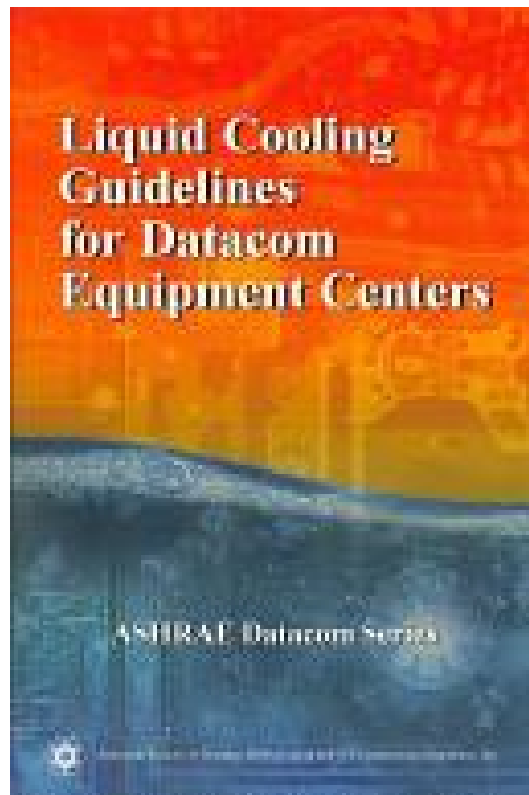

Figure 7. Failure rate projections for air side economizer and water-side economizer for selected US cities. Note that it is assumed that both forms of economizer will result in data center supply air 1.5°C above the outdoor dry bulb.

ASHRAE's Liquid Cooling Guidelines - 1st Edition (2006)



- **Chapter 1** – Introduction
- **Chapter 2** – Facilities Cooling Systems
- **Chapter 3** – Facility Piping Design
- **Chapter 4** – Liquid Cooling Implementation for Datacom Equipment
- **Chapter 5** – Liquid Cooling Infrastructure Requirements for Chilled Water Systems
- **Chapter 6** – Liquid Cooling Infrastructure Requirements for Technology Cooling Systems

Can obtain book @ <http://tc99.ashraetcs.org/>

Typical Liquid Cooling Architecture for a Data Center

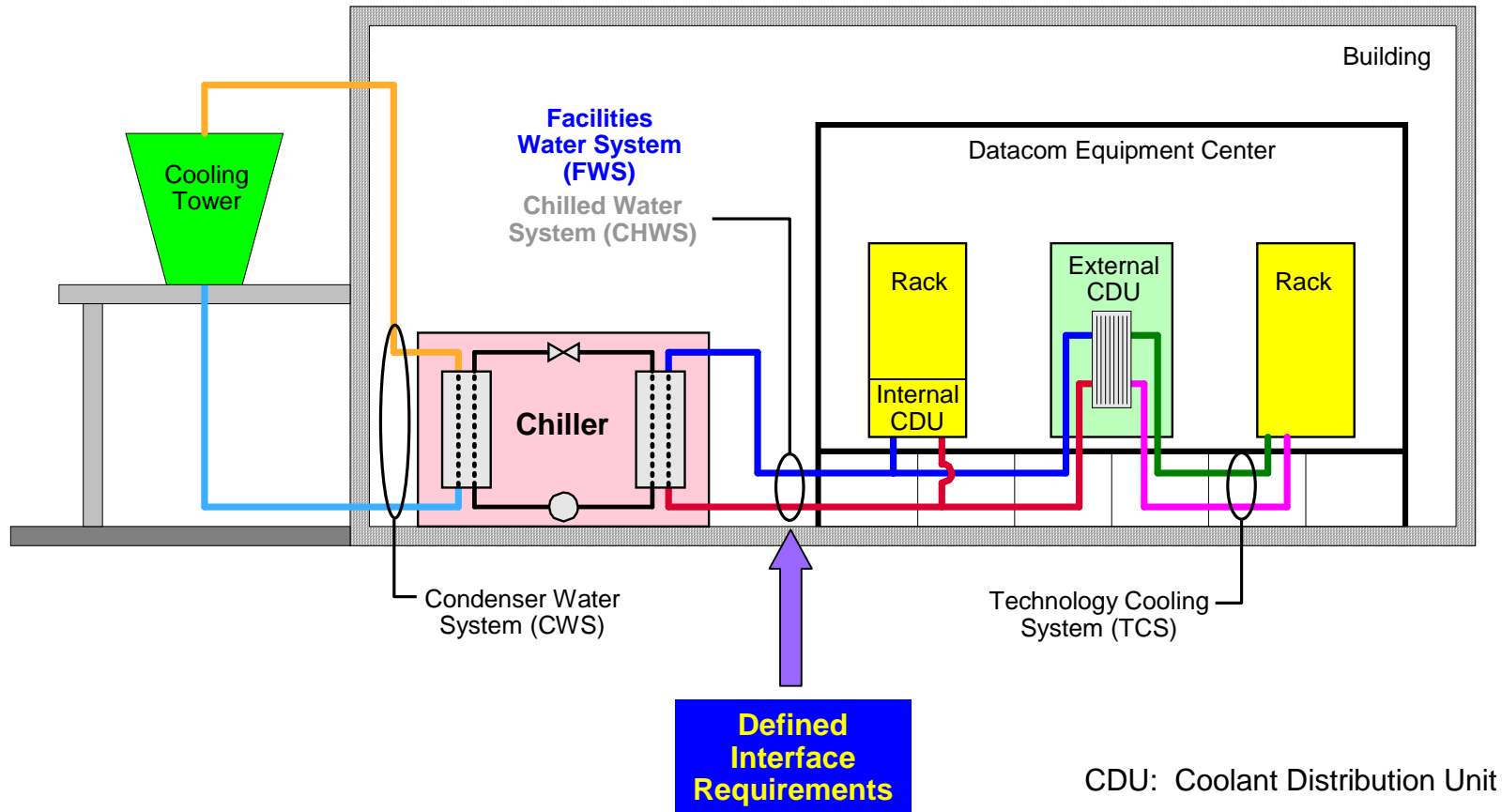

ASHRAE 2011 Liquid Cooling Thermal Guidelines Whitepaper (<http://tc99.ashraetcs.org/>)

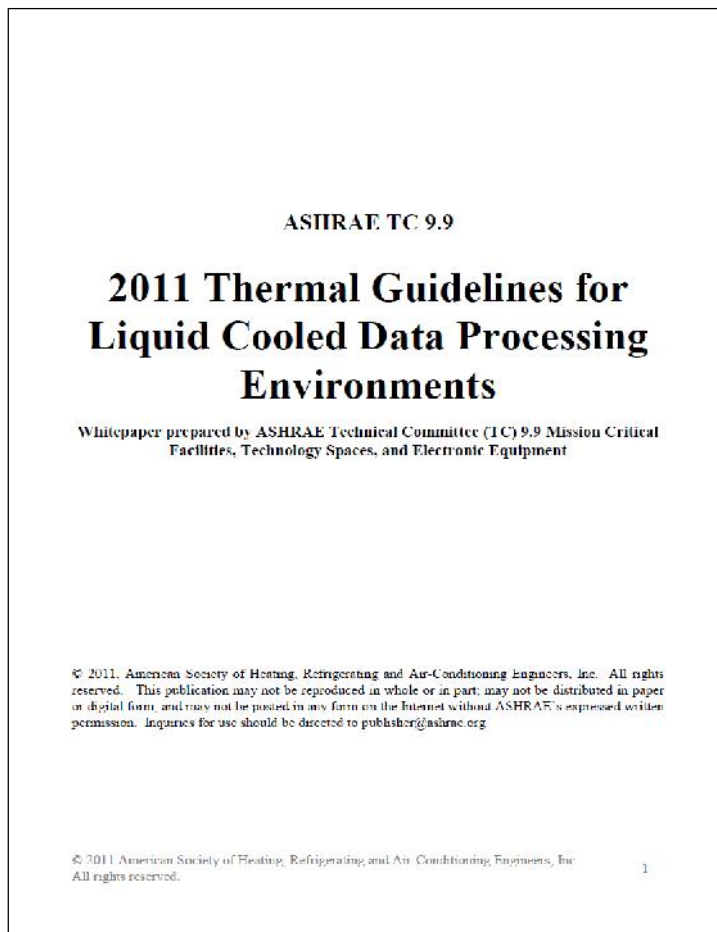

- ✓ Establishes liquid cooling (W) classes analogous to the air cooled classes
- ✓ Reduce number of chiller hours per year
- ✓ Design data center w/o chillers
- ✓ Very similar to Air Cooling Guidelines where customers wanted wider temperature and humidity guidelines
- ✓ US National Labs wanted to run all their HPC data centers w/o chillers being required for entire year as an option

Liquid Cooling Class W1, W2, & W3

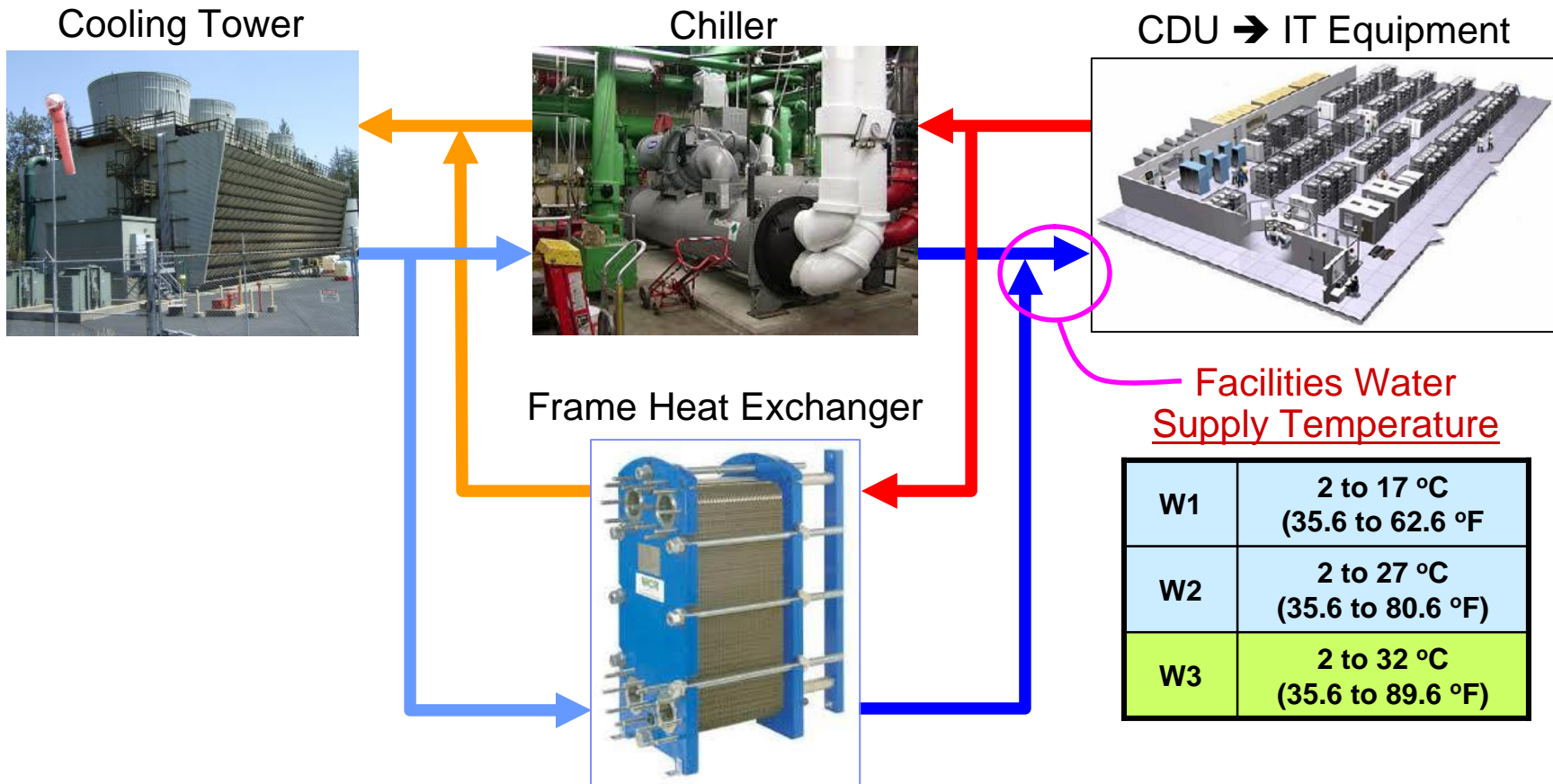

Examples

W1	SGI Altix ICE	7 to 15.5 °C
	HP MCU	7 to 15 °C
	IBM p6 Power 575	6 to 16 °C

W2	IBM p7 Power 775	2 to 20 °C
	IBM BlueGene	16 to 27 °C

Liquid Cooling Class W4

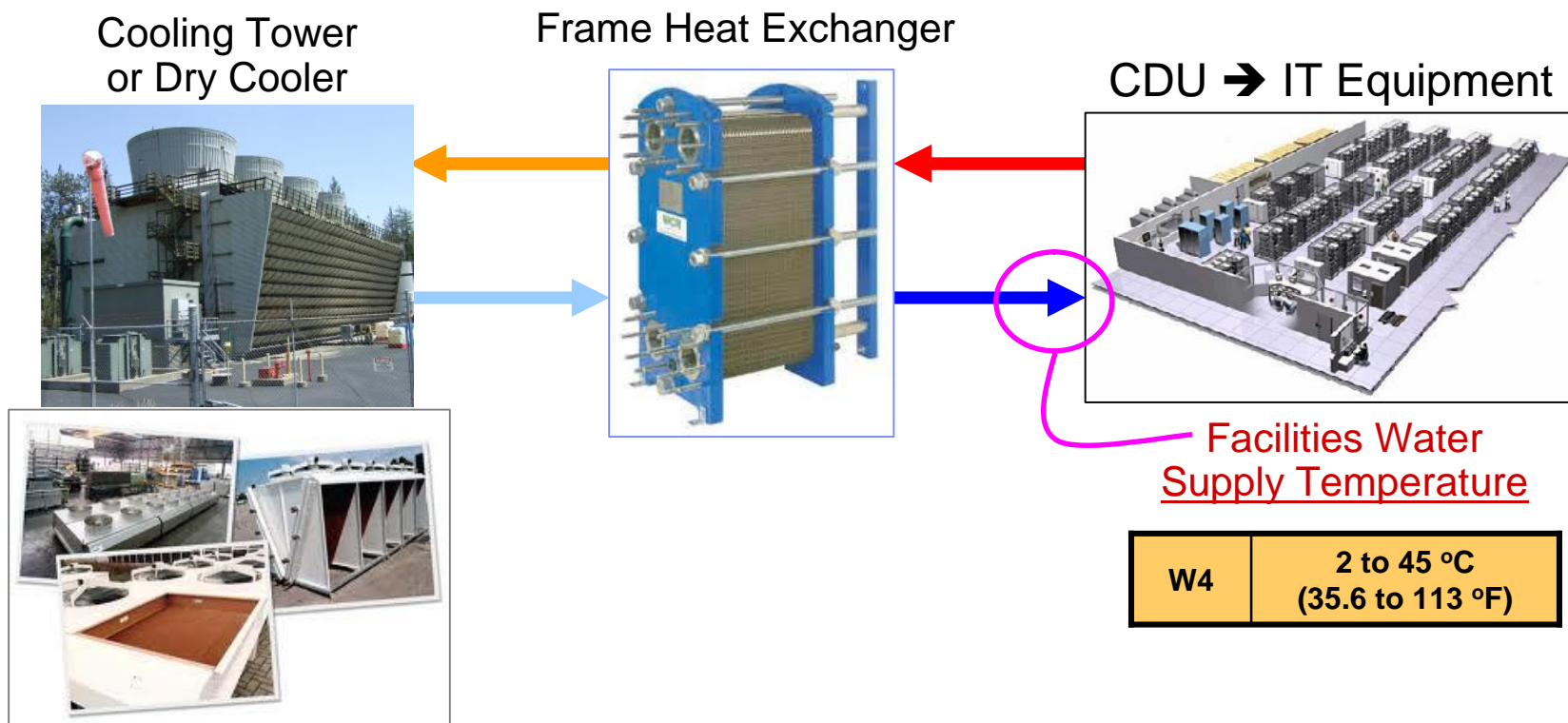

Examples

LRZ SuperMUC	25 to 45 °C
Eurotech Aurora (IBM QPACE)	30 to 40 °C

Liquid Cooling Class W5

Cooling Tower or Dry Cooler



Heat Recovery Systems

- Under-Floor Heating (30-40 °C)
- Radiant Heating (60-70 °C)
- Absorbtion Chillers (60-70 °C)

Frame Heat Exchanger



CDU → IT Equipment

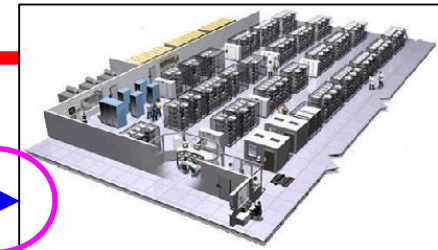

Facilities Water Supply Temperature

W5	> 45 °C (> 113 °F)
----	-----------------------

Examples

IBM Aquasar (ETH Zurich)	65 °C
IBM iDataCool (U. of Regensburg)	65 °C

Liquid Cooling Guidelines - Summary

Liquid Cooling Class	Typical Infrastructure Design		Facility Water Supply Temperature
	Primary Facilities Cooling Equipment	Secondary / Supplemental Cooling Equipment	
W1	Cooling Tower / Chiller	Water Side Economizer	2 to 17 °C (35.6 to 62.6 °F)
W2			2 to 27 °C (35.6 to 80.6 °F)
W3	Cooling Tower	Chiller	2 to 32 °C (35.6 to 89.6 °F)
W4	Water Side Economizer (with Dry Cooler or Cooling Tower)	N/A	2 to 45 °C (35.6 to 113 °F)
W5	Building Heating System	Cooling Tower or Dry Cooler	> 45 °C (> 113 °F)

Class W1/W2: Typically a data center that is traditionally cooled using chillers and a cooling tower but with an optional water side economizer to improve on energy efficiency depending on the location of the data center.

Class W3: For most locations these data centers may be operated without chillers. Some locations will still require chillers.

Class W4: To take advantage of energy efficiency and reduce capital expense, these data centers are operated without chillers.

Class W5: To take advantage of energy efficiency, reduce capital expense with chiller-less operation and also make use of the waste energy, the water temperature is high enough to make use of the water exiting the IT equipment for heating local buildings.

Conclusion / Summary

- Datacenter operational environmental envelopes have been expanded to further minimize the use of chillers throughout the year (results in large energy savings)
- Operation outside the recommended region should be a balance between energy savings and the deleterious effects that may be created in reliability, acoustics, or performance.
- Recommended environmental envelope will continue to be the most used environmental envelope for operating data centers

**Thank You for
your Attention**

Questions ?